

Heat Motor Zone Valves

Engineered for reliability, Taco Heat Motor Zone Valves provide a time proven method for system zoning and control. The exclusive heat motor design operates silently, while the twist off head allows for serviceability without disturbing system connections. Available in a variety of sizes and styles to meet the broad demands of today's systems.



Heat Motor Zone Valves

Application

Taco Heat Motor Zone Valves provide a convenient way to create individual zones or equipment isolation in a hydronic heating system. Utilizing one pump along with multiple zone valves, flow can be started, stopped, or diverted through the system to provide individual room or area comfort control and energy savings. Taco offers many versions and sizes of the Heat Motor Zone Valve to meet all your zone valve needs.

Features

- Proven Performance – Millions in Use. Taco Zone Valves are the Industry's Top Choice for Consistent Performance.
- Rugged Dependability
- Silent Operation
- Twist Off Head
- Patented Construction
- Easy to Install
- Manual Open (Bypass) Lever (570 Only)
- 24 VAC Powered with Isolated End Switch
- 100% Factory Tested
- Made in the USA
- 3 Year head, 5 Year Body Warranty on the 570 Series, 1 Year Warranty on all Other Models

Mounting Positions

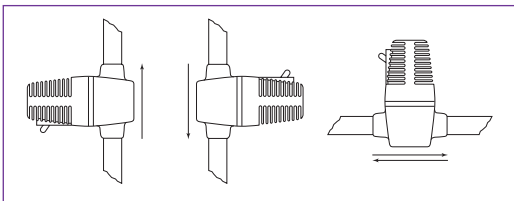

Choose The Right Valve For Your Application

Geothermal Valves (Models 5101G, 556G, 557G)

Designed for high head, open system zone control. The unique end switch design permits control of the heat pump by the valve (see figure A). This allows movement of cold water into the coil before the heat pump actually starts. Available in 3/4" threaded, 3/4" and 1" sweat connections.

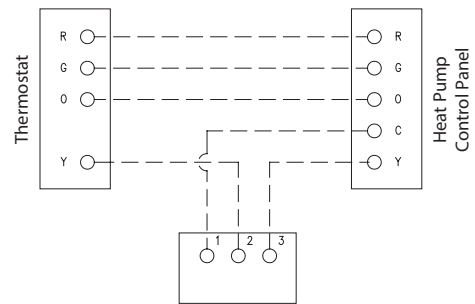

Figure A: Geothermal Zone Valve Wiring to a Heat Pump Control



570 Gold Series (570, 571, 572, 573)

The Gold Series is the industry standard for hydronic heating applications. The quiet and dependable operation has made this valve an industry leader for decades. The manual open lever and twist off head makes installation and service easy. Available in 1/2" – 1-1/4" sweat connections.

Heat Motor Zone Valves

Zone Valve Operation & Wiring

There have always been questions surrounding how the 3-wire terminal block design of the Taco Heat Motor Zone Valve works. The explanation below and associated diagrams explain step-by-step the operation of the zone valve.

As the air temperature at the thermostat drops to the thermostat setting, a normally open contact in the thermostat closes. This completes a circuit between the thermostat, the zone valve transformer and the heat motor of the zone valve power head (terminals 1 and 2). 24 VAC now flows through the wires wrapped around the heater section of the element inside the zone valve heat.

The expandable wax substance inside the element is heated. It expands and pushes the piston inside the element down against the valve stem. Since the valve is an upside down globe valve, this downward push on its stem moves the valve disc away from its seat, opening the valve.

As the piston continues to move down, further opening the valve, the contacts inside the enclosed end switch close as the actuator tab attached to the piston moves away from the end switch. This dry contact end switch closure completes the circuit through terminals 2 and 3 of the power head to

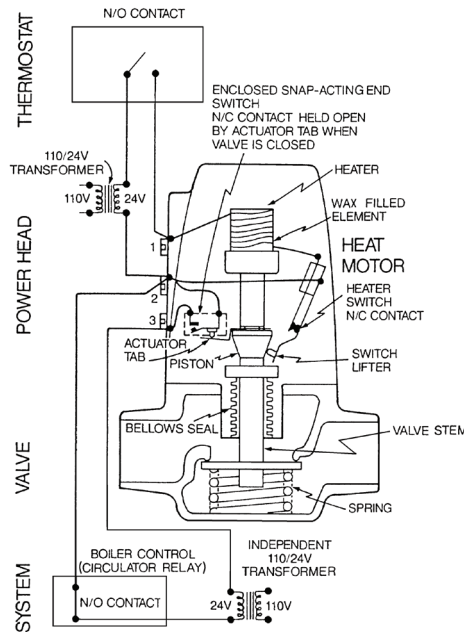

the boiler control (T T) and separate system transformer. The relay in the boiler (or zone control box) starts the circulator. The piston continues to move down until the valve is fully open.

An interruption of current to the power unit heater occurs in the fully open mode because the outer blade of the heater switch is deflected causing the heater element to open, interrupting the 24 VAC power from flowing through the heater wires. As the piston retracts slightly, the contacts on the heater switch meet again, resuming power to the heater wires wrapped around the wax filled element. This slight back and forth motion is repeated as long as the thermostat contact is closed.

When the thermostat is satisfied, its contacts open and cut off the 24 VAC power to the power head. The wax inside the element cools and contracts. The force of the valves spring moves the valve disc up against the valve seat. Hence the valve stem also moves up, pushing the piston back into the element. Now that the heater switch is closed, the snap-acting end switch between terminals 2 and 3 is open.

Wiring Note

While two circuits, each with its own transformer, touch at terminal #2, they do not communicate or interfere with each other in any way (see figure B). Each circuit flows only in that circuit. This occurs because the transformer in either circuit cannot cause a voltage or current driving force to be realized in the other circuit when joined only at one point to that circuit.

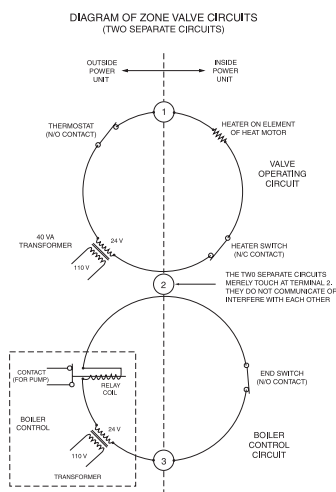
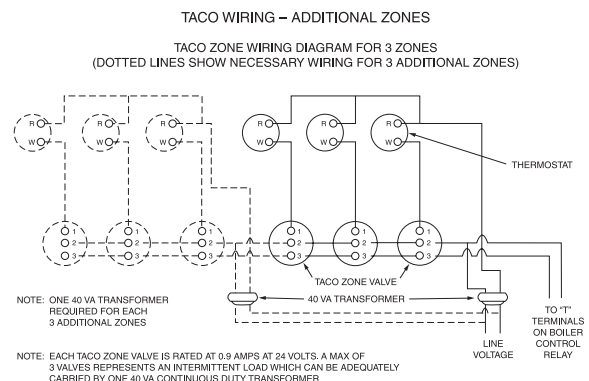

Figure B: Zone Valve Circuits.



Submittal Data Information Heat Motor Zone Valves

Submittal Data # 100-3.2
Supersedes: 06/18/13

Effective: 09/30/19

Models	Connection	Style	Dimensions & Weights								Ship Wt.	
			A		B		C		D		Lbs.	Kg.
			in.	mm	in.	mm	in.	mm	in.	mm		
5101G	3/4" Threaded	2-Way	3-3/8"	86	5-3/8"	136	1-9/16"	40	2"	51	2-1/4	1.0
556G	3/4" Sweat	2-Way	3-3/8"	86	5-3/8"	136	1-9/16"	40	2"	51	2-1/4	1.0
557G	1" Sweat	2-Way	3-5/8"	92	5-3/8"	136	1-9/16"	40	2"	51	2-1/4	1.0
570	1/2" Sweat	2-Way	3-1/16"	78	4-13/16"	122	15/16"	24	2"	51	2-1/4	1.0
571	3/4" Sweat	2-Way	3-3/8"	86	4-13/16"	122	15/16"	24	2"	51	2-1/4	1.0
572	1" Sweat	2-Way	3-5/8"	92	4-13/16"	122	15/16"	24	2"	51	2-1/4	1.0
573	1 1/4" Sweat	2-Way	3-7/8"	98	4-13/16"	122	15/16"	24	2"	51	2-1/4	1.0

Models	Electrical			Performance							Materials of Construction		
	Volts	Hz	Amps	Normal Flow Ranges (GPM)	Cv	Equiv. Ft. of Pipe	Min. Fluid Temp. (°F)	Max. Fluid Temp. (°F)	Max. Working Pressure (psi)	Pump Head Ft. of Water	Body	Stem / Seal	Seat Assy.
5101G	24	60	0.9	4 1/2 - 6	6.1	20	40°	240°	125	150	Bronze	O-Ring Gland	Eng. Polymer
556G	24	60	0.9	4 1/2 - 6	6.1	20	40°	240°	125	150	Bronze	O-Ring Gland	Eng. Polymer
557G	24	60	0.9	6 - 10	7.0	60	40°	240°	125	150	Bronze	O-Ring Gland	Eng. Polymer
570	24	60	0.9	1 - 4 1/2	4.2	10	40°	240°	125	65	Bronze	Bellows	Brass
571	24	60	0.9	4 1/2 - 6	6.1	20	40°	240°	125	65	Bronze	Bellows	Brass
572	24	60	0.9	6 - 10	7.0	60	40°	240°	125	65	Bronze	Bellows	Brass
573	24	60	0.9	10 - 16	7.2	130	40°	240°	125	65	Bronze	Bellows	Brass

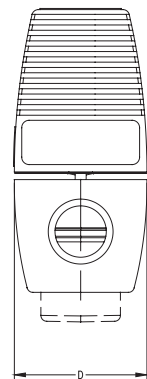
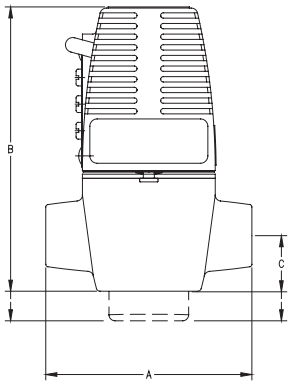

A Taco Family Company

Taco Inc., 1160 Cranston Street, Cranston, RI 02920 / (401) 942-8000 / Fax (401) 942-2360
Taco (Canada) Ltd., 8450 Lawson Road, Unit #3, Milton, Ontario L9T 0J8 / (905) 564-9422 / Fax (905) 564-9436